

Trace and copy.



a a

always

amazing

alligator



b b

boy

baking

blueberries

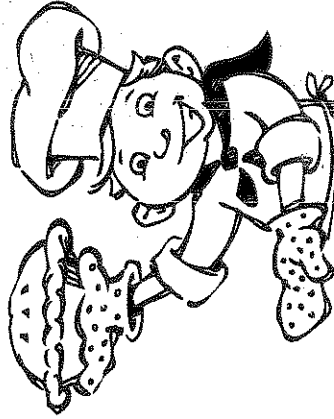

Name: \_\_\_\_\_

Trace and copy.



*c c*

*clever*

*cosmic*

*creature*

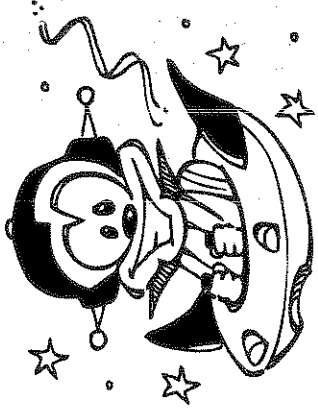

*d d*

*dainty*

*delightful*

*duck*

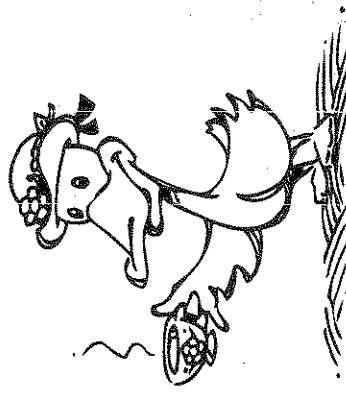

e:

Trace and copy.



e e

electric

eels

entertain

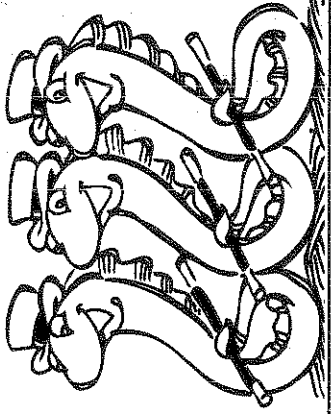

f f

five

flashing

fireflies

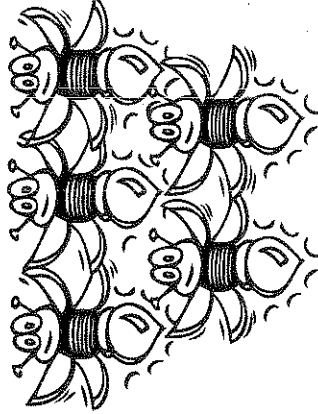

Name: \_\_\_\_\_

Trace and copy.



g g

giant

gentle

giraffe

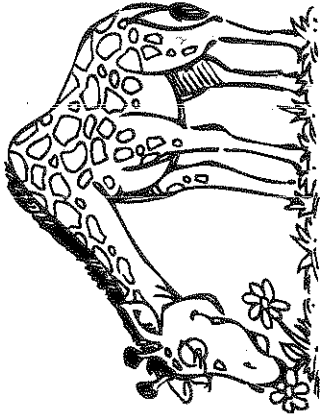

h h

huge

happy

hippo



Trace and copy.

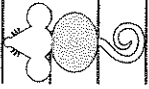

i i

inactive

immense

iguana



j j

jolly

juggling

jester

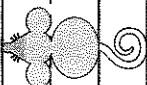

Lowercase Letter Practice

Name: \_\_\_\_\_  
Trace and copy.  
 *k k*  
*karate*



*kicking*  
*koala*

 *l l*  
*lizards*  
*love*  
*leapfrog*

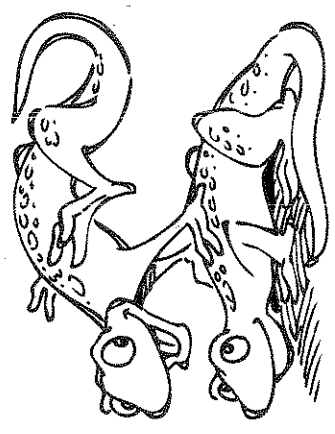



Trace and copy.



m m

messy

muddy

moose



m m

mice

meat

nest

Name: \_\_\_\_\_

Trace and copy.



o o

orange

orange

orange

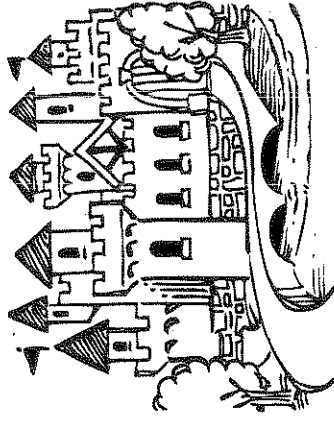

p p

pretty

purple

palace



Trace and copy.



q q  
 quickly  
 quilting  
 queen



r r  
 rickety  
 raft  
 race

Name: \_\_\_\_\_

Trace and copy.

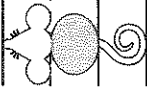

*a a*

*seven*

*sweet*

*strawberries*

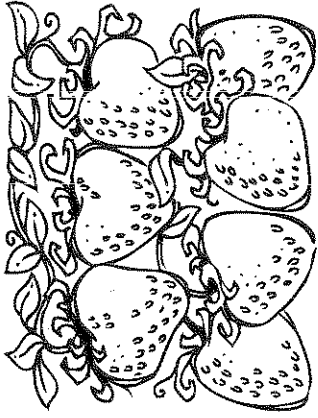

Lowercase Letter Practice



*t t*

*two*

*tumbling*

*tigers*



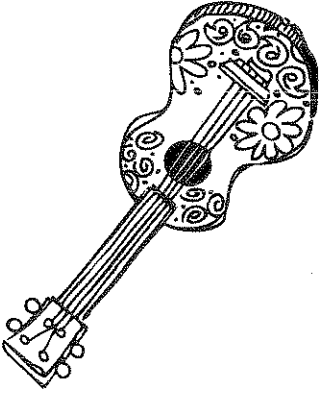

ne:

Trace and copy.



*n n*

*nuseful*

*nunique*

*nkeyboard*



*n n*

*nerry*

*nast*

*nalley*



Lowercase Letter Practice

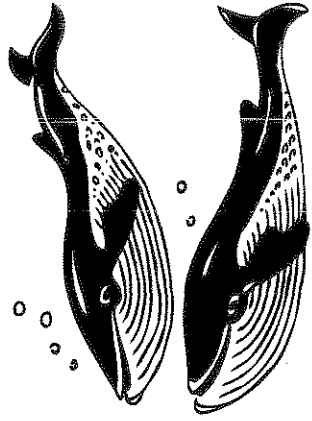

Name: \_\_\_\_\_

Trace and copy.

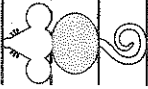

w w

watch

wild

whales

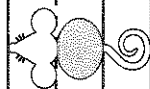
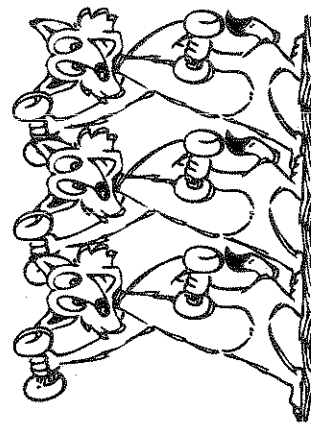

w w

wanted

foxes

exercise

me:

Trace and copy.



y y

yummy

yellow

yams

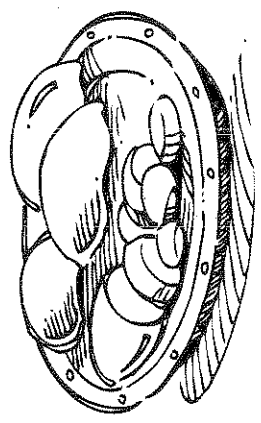

z z

zippy

zebra

zigzags



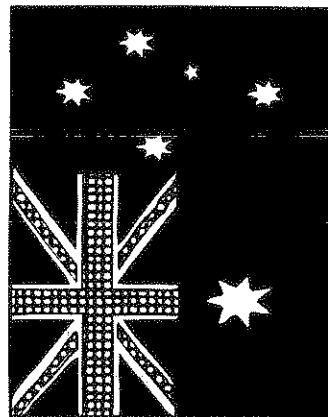

Name:

Trace and copy.



A A

Anna

Adam

Australia

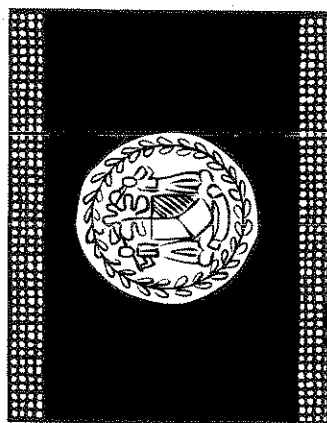

B B

Bradley

Betsy

Belize

Trace and copy.

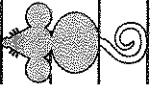

C C

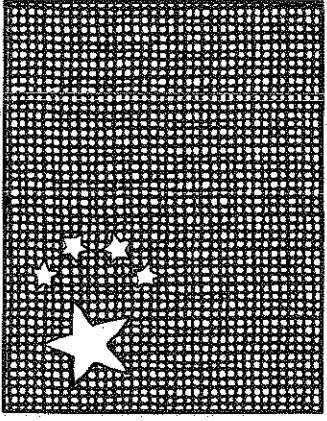

Cora

Caleb

Chima



D D

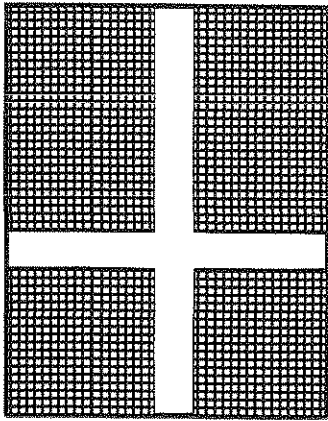

Dustin

Delia

Demmark

Uppercase Letter Practice

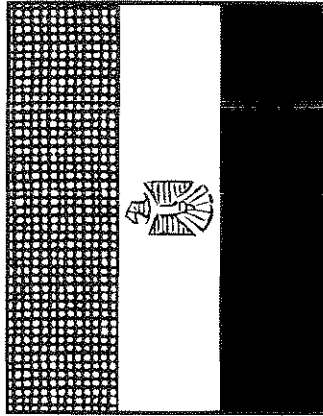

Name: \_\_\_\_\_

Trace and copy.

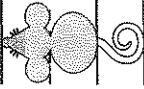

E E

Ebony

Eric

Egypt

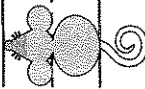
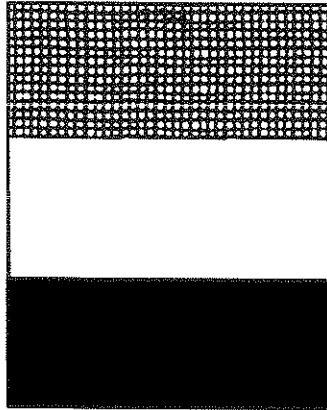

F F

Felipe

Fiona

France



Trace and copy.



X X

Ximiny

Xregory

Xermany

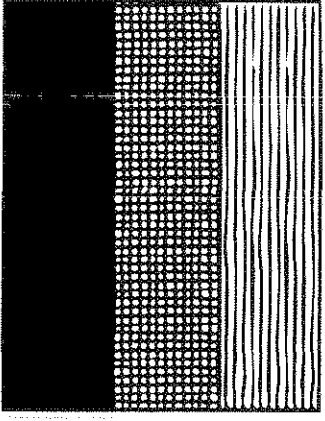

X X

Xector

Xolby

Xotland

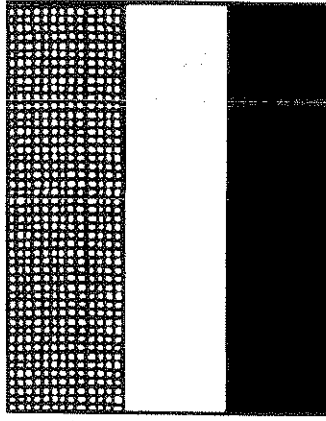

Uppercase Letter Practice

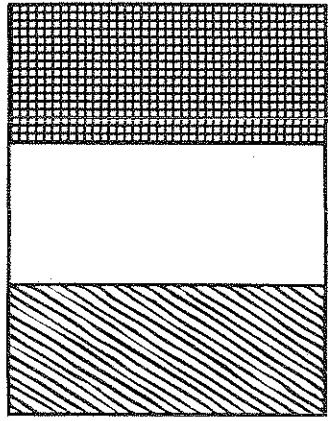

Name:

Trace and copy.

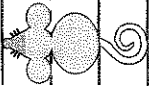

I I

Isabelle

Ivan

Italy



J J

Jacke

Jill

Japan

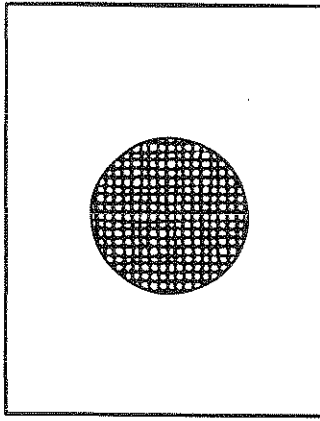

e:

Trace and copy.



R R

Kyle

Kelley

Kemaya

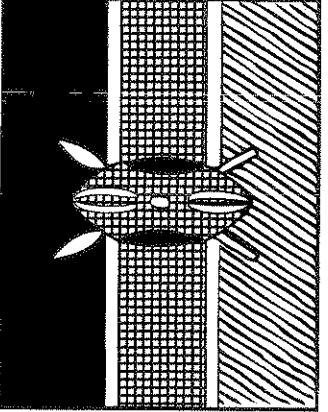

L L

Leo

Lola

London

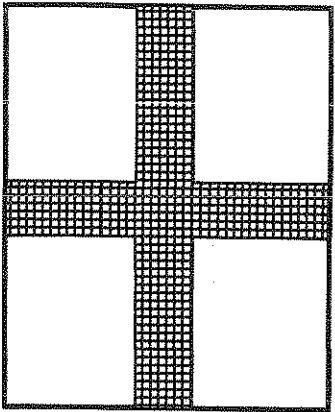

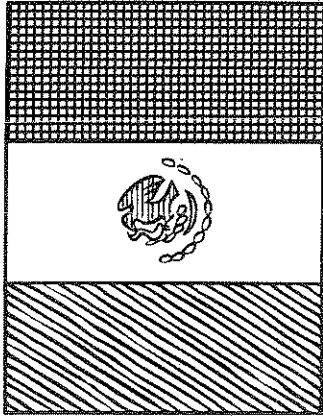

Name:

Trace and copy.

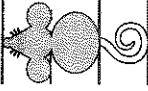

M M

Megan

Michael

Mexico

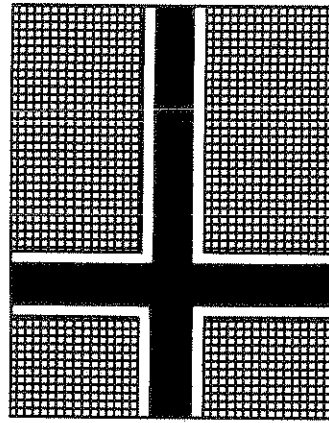

N N

Nora

Neil

Norway

Name: \_\_\_\_\_

Trace and copy.



*Q Q*

*Queen*

*Olga*

*Ohio*

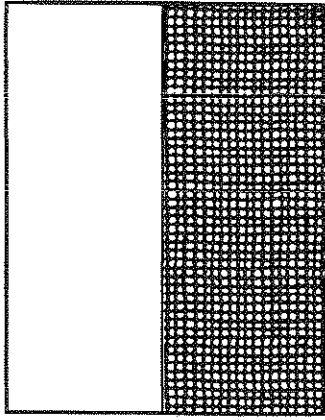

*P P*

*Pablo*

*Paige*

*Potam*

Uppercase Letter Practice

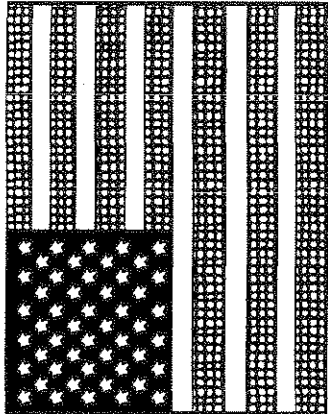

Name: \_\_\_\_\_

Trace and copy.



Q Q

Quinn

Quinn

Quebec

Uppercase Letter Practice

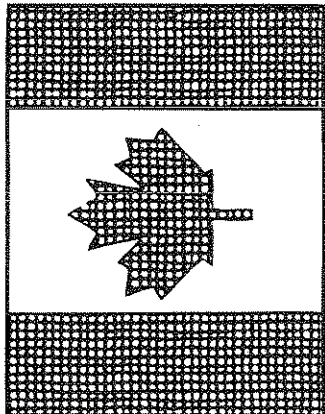

R R

Ryan





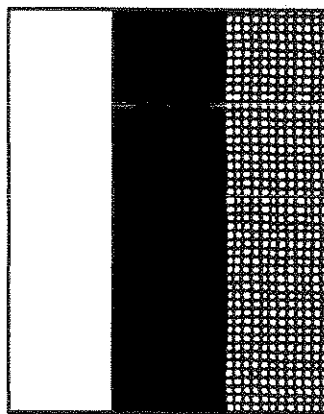





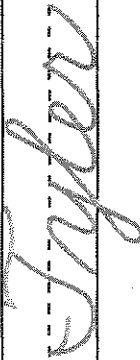

Rosa

Russia



e:

Trace and copy.

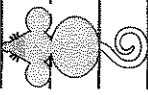

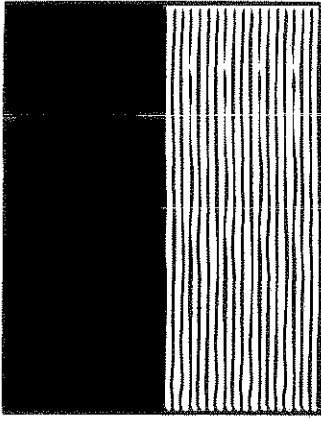

Name: \_\_\_\_\_

Trace and copy.



U u

Ursula

Umberto

Ukraine

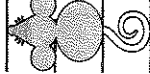
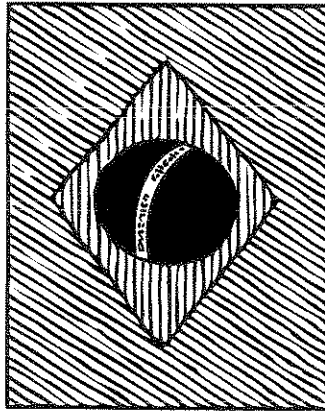

V v

Valerie

Victor

Vitória





Name: \_\_\_\_\_

Trace and copy.



W W

Wendy

Wyatt

Wales



K K

Karrier

Kenna

Kamthi

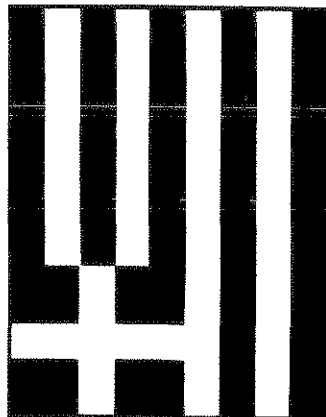

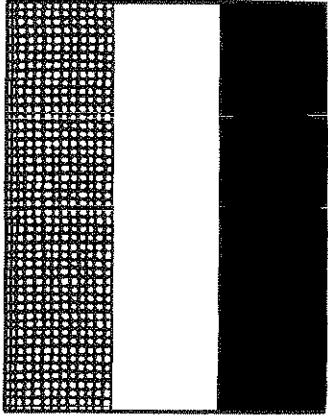

Name: \_\_\_\_\_

Trace and copy.



Y y

Yotamda

Yuri

Yerrem

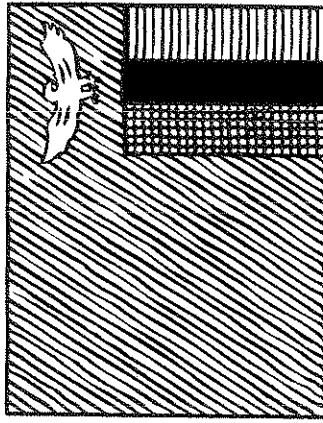

Z z

Zach

Zelada

Zambia



*Sunday*

*Sun.*

*Sunday is a terrific day.*



*Monday*

*Mon.*

*Monday is a fun day.*



Tuesday

Tues.

Tuesday is a good day.

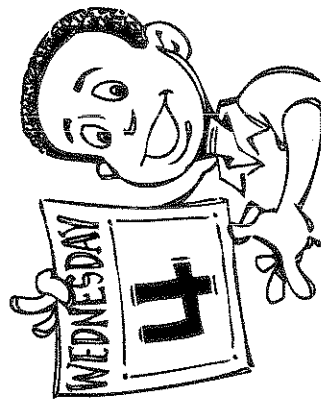

Wednesday

Wed.

Wednesday is a wild day.

Name: \_\_\_\_\_

*January is the first month.  
February is the second month.  
March is the third month.  
April is the fourth month.*

Copy the sentences in your best cursive handwriting.

Handwriting practice lines consisting of multiple sets of three horizontal lines (top solid, middle dashed, bottom solid) for copying the cursive sentences.

Months of the Year

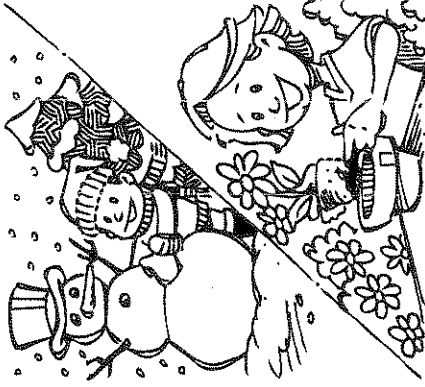

Name: \_\_\_\_\_

Months of the Year



*May is the fifth month.*

*June is the sixth month.*

*July is the seventh month.*

*August is the eighth month.*

Copy the sentences in your best cursive handwriting.

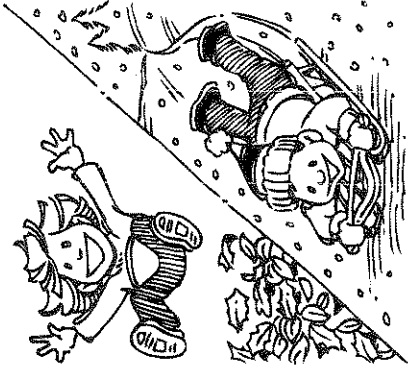

*September is the ninth month.*

*October is the tenth month.*

*November is the eleventh month.*

*December is the twelfth month.*

Copy the sentences in your best cursive handwriting.

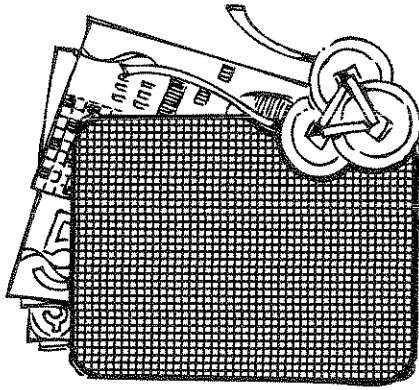

Children in Malaysia receive red packets  
of money for their birthdays.  
They eat a dessert made of cake and butter.

Copy the sentences in your best cursive handwriting.

Handwriting practice lines consisting of multiple sets of three horizontal lines: a solid top line, a dashed middle line, and a solid bottom line.



Children in Finland eat cakes with three layers.

They play a game in which they fish for prizes.

Copy the sentences in your best cursive handwriting.

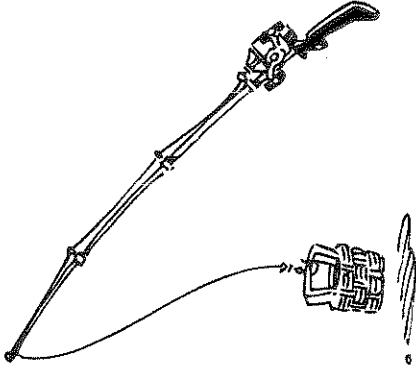

Name: \_\_\_\_\_

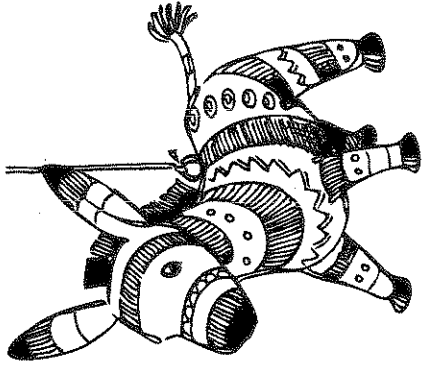

*Children in Mexico have three wishes when they blow out their birthday candles. Then, they try to break open a piñata.*

Copy the sentences in your best cursive handwriting.

Handwriting practice lines consisting of multiple sets of three horizontal lines: a solid top line, a dashed middle line, and a solid bottom line.

Name: \_\_\_\_\_

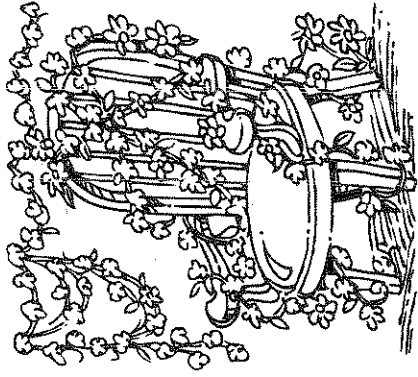

Children in the Netherlands sit in decorated chairs.

They play a game in which they try to eat cookies hanging from strings.

Copy the sentences in your best cursive handwriting.

Handwriting practice lines consisting of multiple rows of solid top and bottom lines with a dashed midline for cursive letter height guidance.

Name: \_\_\_\_\_

**Birthdays around the World**

*Children in Sweden are awakened by their  
singing families.  
They are served hot chocolate before getting  
out of bed.*

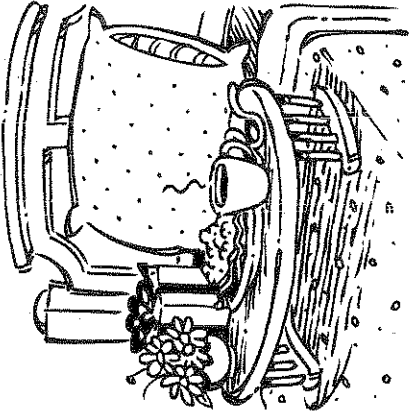

Copy the sentences in your best cursive handwriting.

Handwriting practice lines consisting of multiple rows of solid top and bottom lines with a dashed midline for cursive practice.

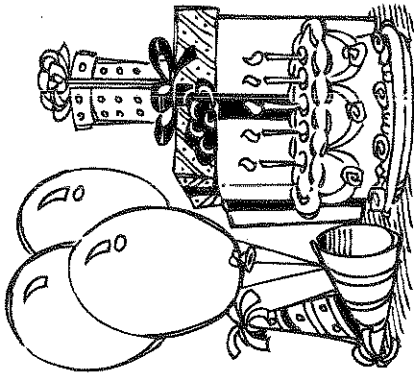

A birthday is a special day to  
celebrate everywhere.  
A cake, gifts, and games are part of  
most birthday celebrations.

Copy the sentences in your best cursive handwriting.

3-D Figures

Name: \_\_\_\_\_

Copy the sentences in your best cursive handwriting.

*Baseballs and soccer balls are spheres.*

*Basketballs are also spheres.*



*Blocks are cubes.*

*Dice are also cubes.*

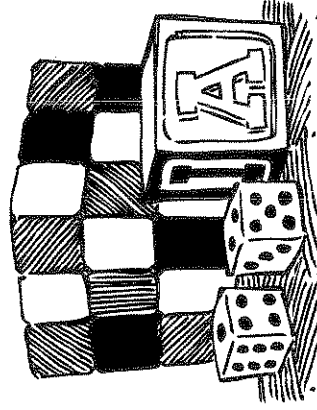

ne:

Copy the sentences in your best cursive handwriting.

Soda cans and trash cans are cylinders.

Markers are also cylinders.

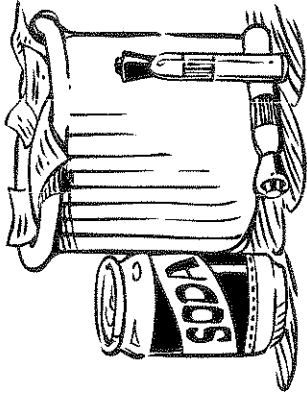

Ice cream cones and party hats are cones.

Megaphones are also cones.

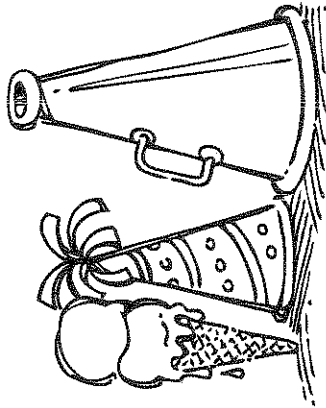

Name: \_\_\_\_\_

Write the name of each figure on the line. Use your best cursive handwriting.

<i>cylinder</i>	<i>cube</i>	<i>sphere</i>	<i>cone</i>
-----------------	-------------	---------------	-------------



\_\_\_\_\_

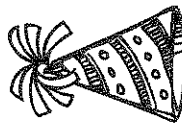

\_\_\_\_\_



\_\_\_\_\_



\_\_\_\_\_

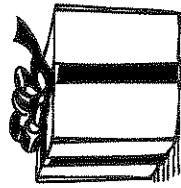

\_\_\_\_\_

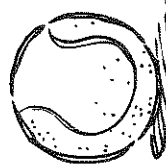

\_\_\_\_\_

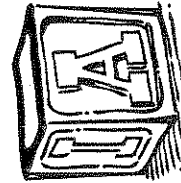

\_\_\_\_\_

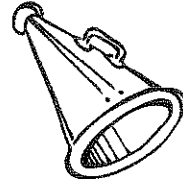

\_\_\_\_\_



Name: \_\_\_\_\_

*There are many different types of animals  
in the zoo.  
Animals are grouped by what they have  
in common.*

Copy the sentences in your best cursive handwriting.

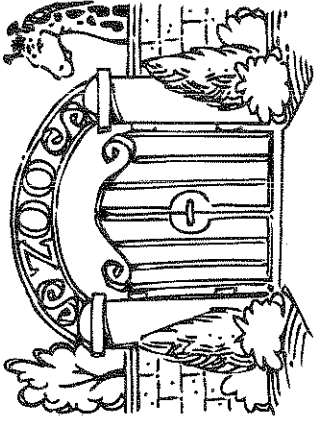

Handwriting practice lines consisting of multiple sets of three horizontal lines (top solid, middle dashed, bottom solid) for copying the text above.

Name: \_\_\_\_\_

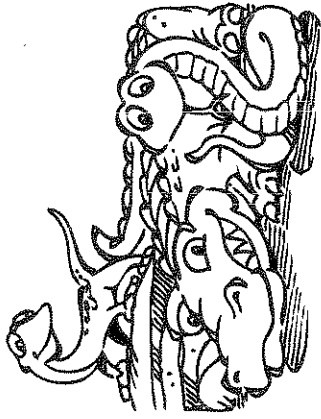

*Reptiles have scales that cover their bodies.  
Snakes, lizards, and alligators are reptiles.*

Copy the sentences in your best cursive handwriting.

Handwriting practice lines consisting of multiple sets of three horizontal lines (top solid, middle dashed, bottom solid) for copying the text above.

Amphibians can walk on land  
and swim in water.  
Toads, newts, and salamanders  
are amphibians.

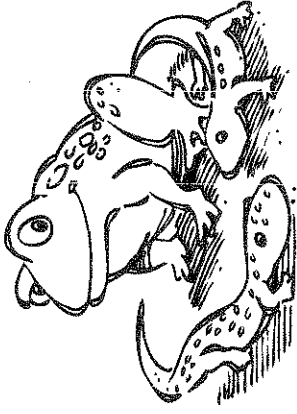

Copy the sentences in your best cursive handwriting.

Name: \_\_\_\_\_

Zoo Animals

Mammals have hair or fur  
covering their bodies.  
Tigers, bears, and monkeys  
are mammals.



Copy the sentences in your best cursive handwriting.

Handwriting practice lines consisting of multiple sets of three horizontal lines (top solid, middle dashed, bottom solid) for copying the text above.

Birds have feathers, wings, and beaks  
or bills.  
Eagles, flamingos, and owls are birds.

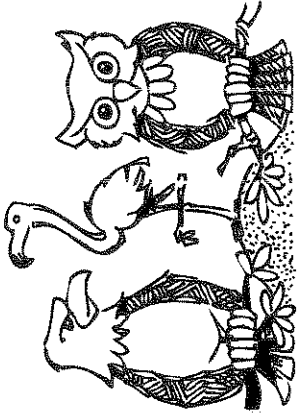

Copy the sentences in your best cursive handwriting.

Name: \_\_\_\_\_

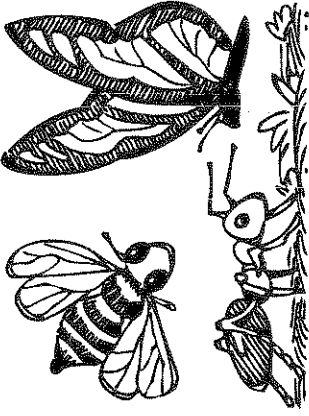

*Insects have three body segments,  
six legs, and two antennae.  
Bees, ants, and butterflies are insects.*

Copy the sentences in your best cursive handwriting.

Handwriting practice lines consisting of multiple rows of solid top and bottom lines with a dashed midline for cursive letter height guidance.

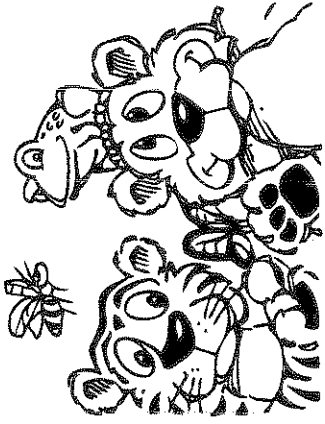

Write the animal names in alphabetical order. Use your best cursive handwriting.

<i>tiger</i>	<i>bee</i>	<i>snake</i>
<i>monkey</i>	<i>newt</i>	<i>lizard</i>
<i>alligator</i>	<i>toad</i>	<i>eagle</i>
<i>flamingo</i>	<i>butterfly</i>	<i>bear</i>

1. \_\_\_\_\_

2. \_\_\_\_\_

3. \_\_\_\_\_

4. \_\_\_\_\_

5. \_\_\_\_\_

6. \_\_\_\_\_

Name: \_\_\_\_\_

Landforms

*Landforms are physical features that cover  
the earth's surface.  
Valleys, plateaus, mountains, plains,  
canyons, and islands are landforms.*

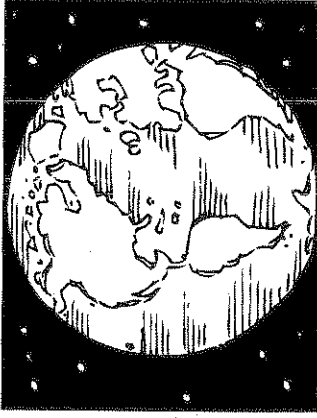

Copy the sentences in your best cursive handwriting.



Copy the sentences in your best cursive handwriting.

A canyon is a large, narrow valley with steep sides.



An island is an area of land surrounded by water.



Rocks

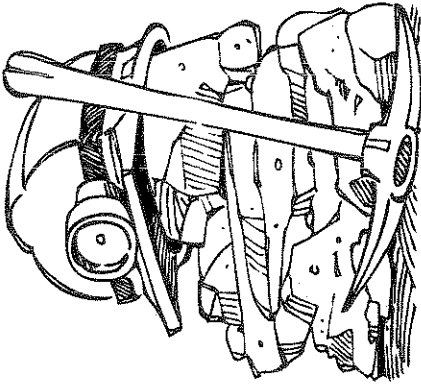

Name: \_\_\_\_\_

*Rocks are found everywhere on the earth's surface.*

*The oldest known rock is about four billion years old.*

Copy the sentences in your best cursive handwriting.

Handwriting practice lines consisting of multiple sets of three horizontal lines: a solid top line, a dashed middle line, and a solid bottom line.

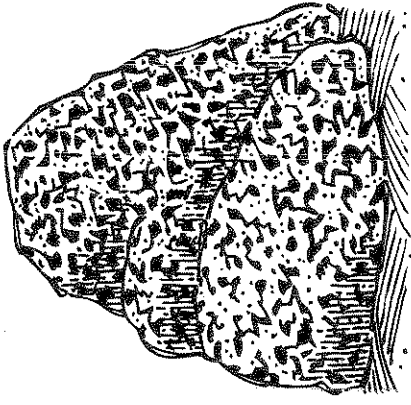

Igneous rocks form when magma cools.  
Granite is a type of igneous rock.

Copy the sentences in your best cursive handwriting.

Name: \_\_\_\_\_

## Rocks

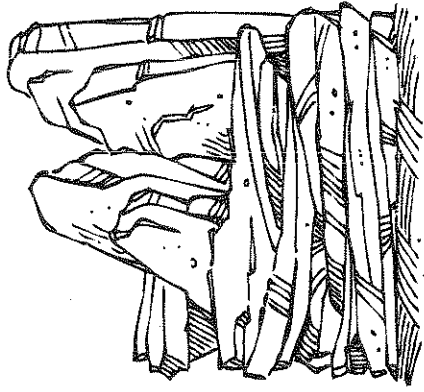

*Sedimentary rocks form when layers of  
rock, sand, and mud are compressed.  
Sandstone is a type of sedimentary rock.*

Copy the sentences in your best cursive handwriting.

Handwriting practice lines consisting of multiple rows of solid top and bottom lines with a dashed midline for cursive letter height guidance.

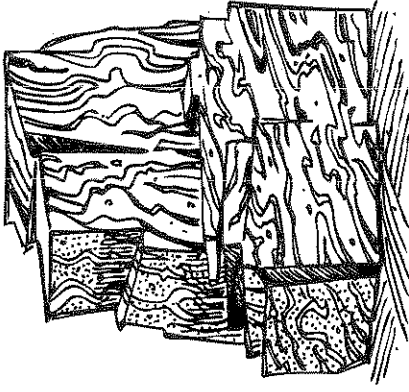

Metamorphic rocks form when heat and pressure change existing rocks.  
Marble is a type of metamorphic rock.

Copy the sentences in your best cursive handwriting.

Name: \_\_\_\_\_

The Moon

*As the moon orbits the earth, its shape seems to change.  
It looks different because of its position in relation to  
the sun and the earth.*

Copy the sentences in your best cursive handwriting.

Handwriting practice lines consisting of multiple sets of three horizontal lines (top solid, middle dashed, bottom solid) for copying the text above.

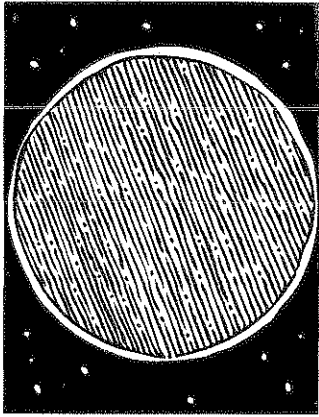

ie: Copy the sentences in your best cursive handwriting.

*During a new moon, the moon is between  
the sun and the earth.*

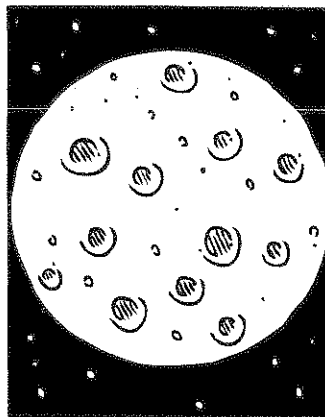

*During a full moon, the earth is between  
the sun and the moon.*

Name: \_\_\_\_\_

Copy the sentences in your best cursive handwriting.

*When the lit portion of the moon is growing,  
the moon is waxing.*

*When the lit portion of the moon is shrinking,  
the moon is waning.*



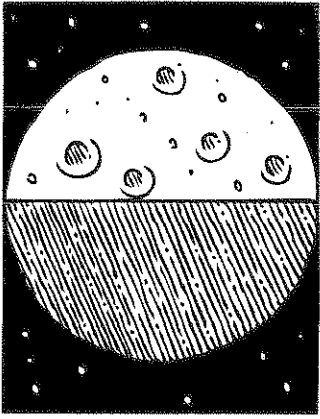

Copy the sentences in your best cursive handwriting.

*A half moon that is waxing is called a first quarter moon.*

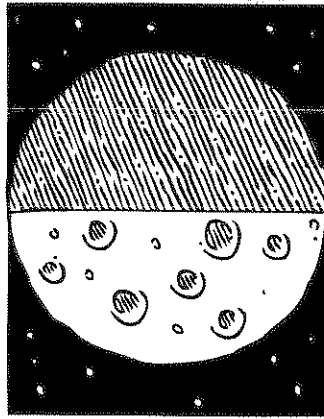

*A half moon that is waning is called a last quarter moon.*

The Moon

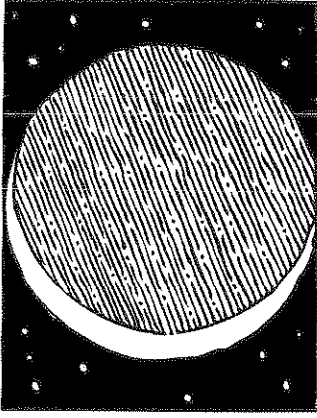

Name: \_\_\_\_\_

Copy the sentences in your best cursive handwriting.

*When less than half of the moon is lit,  
it is called a crescent moon.*

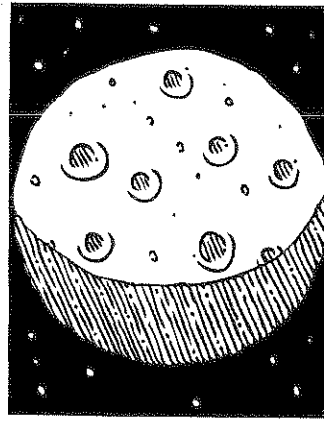

*When more than half of the moon is lit,  
it is called a gibbous moon.*

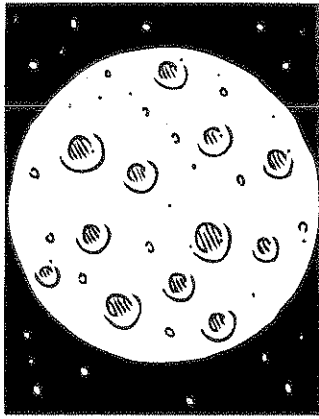

On July 20, 1969, astronauts Neil Armstrong  
and Buzz Aldrin became the first people to  
walk on the moon.

Copy the sentence in your best cursive handwriting.

Name: \_\_\_\_\_

## The Human Skeleton

*There are 206 bones in the adult human skeleton. The skeleton supports the body and protects the organs within the body.*

Copy the sentences in your best cursive handwriting.

Handwriting practice lines consisting of multiple sets of three horizontal lines: a solid top line, a dashed middle line, and a solid bottom line.

The skull protects the brain.

It also forms the shape of the face.

The skull is connected to the top of the spine.

Copy the sentences in your best cursive handwriting.

Handwriting practice lines consisting of multiple sets of three horizontal lines (top solid, middle dashed, bottom solid) for copying the text above.

Name: \_\_\_\_\_

## The Human Skeleton

The spine has 33 linked bones called vertebrae.  
The spine protects the spinal cord and helps you stand upright.

Copy the sentences in your best cursive handwriting.

Handwriting practice lines consisting of multiple sets of three horizontal lines (top solid, middle dashed, bottom solid) for copying the text above.

*There are 12 pairs of ribs in the rib cage.  
The rib cage protects the heart, the lungs,  
and parts of other organs.*

Copy the sentences in your best cursive handwriting.

Name: \_\_\_\_\_

*There are 3 bones in each arm.*

*There are 27 bones in each hand.*

*The bones in the hand help you hold objects.*

Copy the sentences in your best cursive handwriting.

Handwriting practice lines consisting of multiple sets of three horizontal lines (top solid, middle dashed, bottom solid) for copying the cursive sentences.



ne:

*There are 3 bones in each leg.*

*There are 26 bones in each foot.*

*The bones in the feet help with balance.*

Copy the sentences in your best cursive handwriting.

Name: \_\_\_\_\_

Explorers

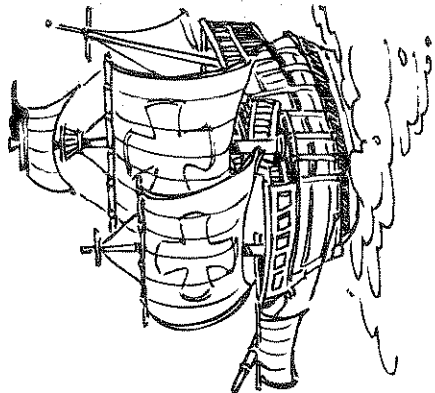

In 1492, Christopher Columbus sailed  
west from Spain.  
He landed on a small island called  
San Salvador.

Copy the sentences in your best cursive handwriting.



*Amerigo Vespucci explored South America  
and identified the New World.  
America was named after him.*

Copy the sentences in your best cursive handwriting.

Handwriting practice lines consisting of multiple sets of three horizontal lines: a solid top line, a dashed middle line, and a solid bottom line.

Name: \_\_\_\_\_

Explorers

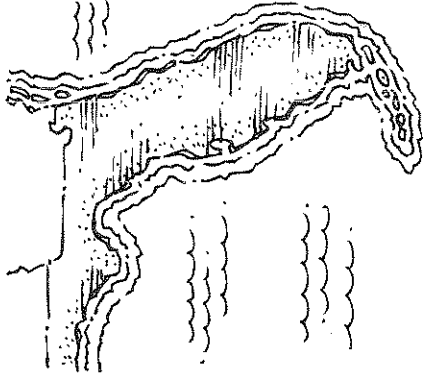

*Juan Ponce de León discovered and  
named Florida.  
He also explored the Gulf of Mexico.*

Copy the sentences in your best cursive handwriting.

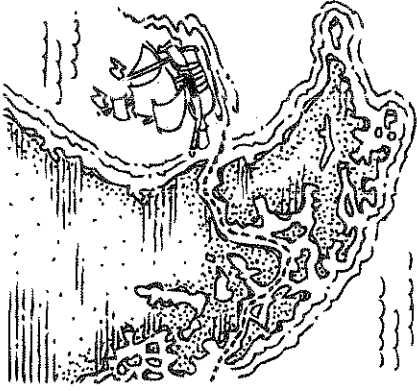

Ferdinand Magellan was the first explorer  
to sail around the world.  
He also found a shortcut from the  
Atlantic Ocean to the Pacific Ocean.

Copy the sentences in your best cursive handwriting.



Name: \_\_\_\_\_  
Copy the sentences in your best cursive handwriting.

*The largest known bubble gum bubble  
was 20 inches wide.*

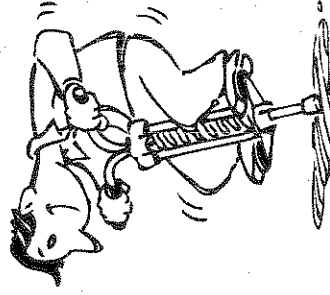

*The longest nonstop distance jumped  
on a pogo stick was 23.11 miles.*

Copy the sentences in your best cursive handwriting.

*The largest ice cream sundae weighed*

*54,917 pounds.*

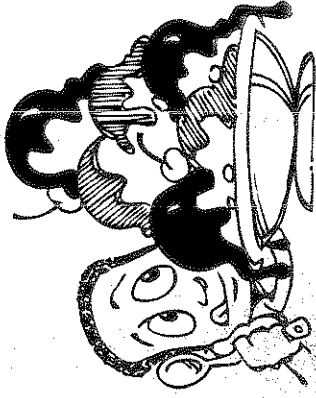

*The largest birthday cake made weighed*

*128,238 pounds.*

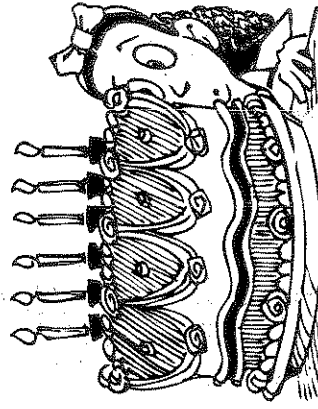

Name: \_\_\_\_\_

Copy the sentences in your best cursive handwriting.

*The largest water balloon fight had  
2,849 people and 55,000 balloons.*

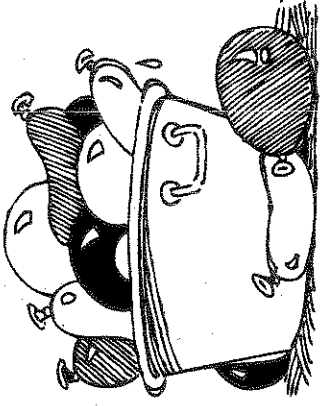

*The fastest time for a dog to unroll a  
car window was 11.34 seconds.*

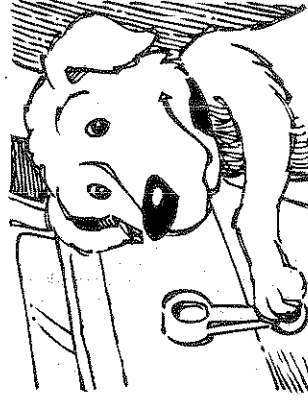



Copy the sentences in your best cursive handwriting.

The fastest time to make 100 paper cranes  
was 1 hour, 38 minutes, 36 seconds.

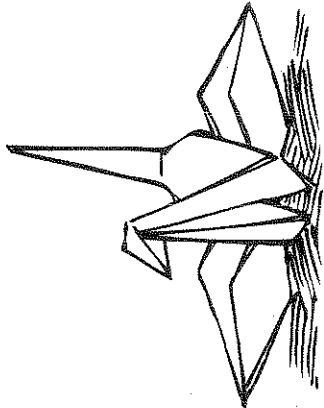

The largest known Komodo dragon  
measured 10 feet, 2 inches long.



Name: \_\_\_\_\_

Word Problems

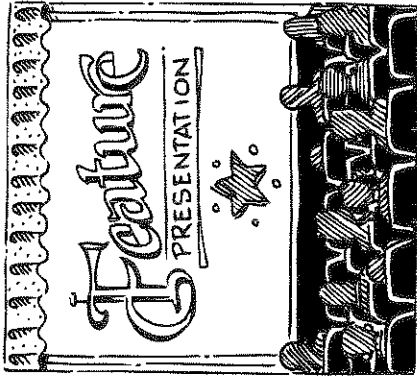

*A movie theater has 9 rows. If each row has 10 seats, how many people can sit in the theater?*

Copy the word problem in your best cursive handwriting. Then, solve the problem.

Handwriting practice lines consisting of multiple rows of solid top and bottom lines with a dashed midline for cursive practice.

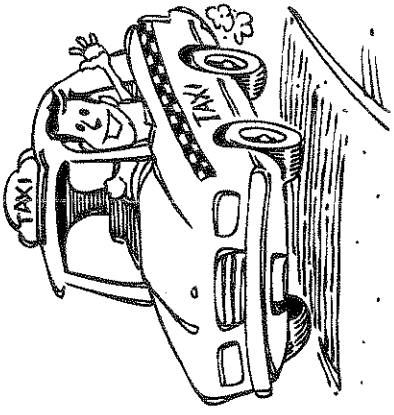

Jon calls a taxi at 1:00. He needs to be at the airport by 2:00. If the taxi comes 22 minutes after he calls, how much time does he have left?

Copy the word problem in your best cursive handwriting. Then, solve the problem.

Name: \_\_\_\_\_

Word Problems

*Karen needs 15 beads to finish a bracelet she is making. If each bag has 5 beads, how many bags of beads does Karen need to buy?*

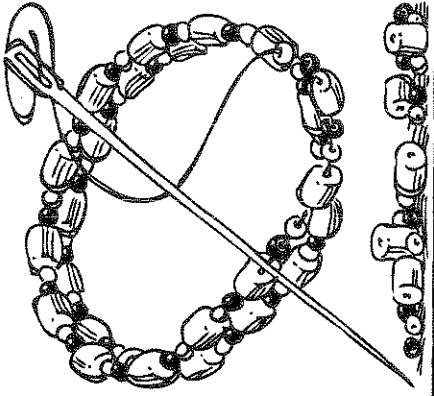

Copy the word problem in your best cursive handwriting. Then, solve the problem.

Handwriting practice lines consisting of a solid top line, a dashed middle line, and a solid bottom line. There are eight sets of these lines provided for copying and solving the problem.

me:

Trace and copy the number words in your best cursive handwriting.

one

ten

hundred

thousand

Name: \_\_\_\_\_

Trace and copy the number words in your best cursive handwriting.

fifty-one

thirty-eight

forty-two

sixty-three

ne:

Trace and copy the number words in your best cursive handwriting.

two hundred ninety-nine

five hundred seventy-three

one hundred thirty-eight

six hundred forty-five

Name: \_\_\_\_\_

Number Words

Trace and copy the number words in your best cursive handwriting.

nine thousand fourteen

two thousand fifty-six

six thousand one hundred

eight thousand seventy



*A literary genre is a category of writing.  
Fiction, nonfiction, drama, poetry, essays, and  
folktales are literary genres.*

Copy the sentences in your best cursive handwriting.

Name: \_\_\_\_\_

Literary Genres

*Fiction uses characters, settings, and plots to describe made-up events.*

*Nonfiction uses real people, settings, and plots to describe true events.*

Copy the sentences in your best cursive handwriting.

\_\_\_\_\_

\_\_\_\_\_

\_\_\_\_\_

\_\_\_\_\_

\_\_\_\_\_

\_\_\_\_\_

\_\_\_\_\_

\_\_\_\_\_

\_\_\_\_\_

\_\_\_\_\_

\_\_\_\_\_

\_\_\_\_\_

\_\_\_\_\_

\_\_\_\_\_

\_\_\_\_\_

\_\_\_\_\_

\_\_\_\_\_

\_\_\_\_\_

\_\_\_\_\_

\_\_\_\_\_

\_\_\_\_\_

\_\_\_\_\_

\_\_\_\_\_

*A drama is a story written to be performed onstage.  
Poetry is often short and is written with rhythm and sometimes rhyme.*

Copy the sentences in your best cursive handwriting.

Handwriting practice lines consisting of multiple sets of three horizontal lines (top solid, middle dashed, bottom solid) for copying the text above.

Name: \_\_\_\_\_

*An essay shows an author's opinion  
on a topic.  
A folktale is a timeless tale that is  
shared between people.*

Copy the sentences in your best cursive handwriting.

Handwriting practice lines consisting of multiple sets of three horizontal lines: a solid top line, a dashed middle line, and a solid bottom line.

*A sentence is a group of words that tells a complete thought.*

*A fragment is a group of words that does not tell a complete thought.*

Copy the sentences in your best cursive handwriting.

Name: \_\_\_\_\_

*A declarative sentence is a statement.*

*It ends with a period.*

*Carla went to the library.*

*Thomas had a salad for dinner.*

Copy the sentences in your best cursive handwriting.

Handwriting practice lines consisting of multiple rows of solid top and bottom lines with a dashed midline for cursive letter height guidance.

An interrogative sentence asks a question.

It ends with a question mark.

Can we go to the park?

Do you enjoy playing chess?

Copy the sentences in your best cursive handwriting.

Handwriting practice lines consisting of multiple sets of three horizontal lines: a solid top line, a dashed middle line, and a solid bottom line.

Name: \_\_\_\_\_

*An imperative sentence gives a command.*

*It ends with a period.*

*Please shut the door.*

*Run to the finish line.*

Copy the sentences in your best cursive handwriting.

Handwriting practice lines consisting of multiple sets of three horizontal lines: a solid top line, a dashed middle line, and a solid bottom line.



*An exclamatory sentence shows strong emotion.*

*It ends with an exclamation point.*

*This water is cold!*

*These cookies are delicious!*

Copy the sentences in your best cursive handwriting.

Handwriting practice lines consisting of multiple sets of three horizontal lines (top solid, middle dashed, bottom solid) for copying the sentences above.

Name: \_\_\_\_\_

Copy each sentence in the correct category. Use your best cursive handwriting.

<p><i>Sue is in my class.</i></p> <p><i>How are you today?</i></p>	<p><i>You are my best friend!</i></p> <p><i>Please pass the salt.</i></p>
--	---

Declarative

Interrogative

Imperative

Exclamatory

A common noun names a person, place, or thing.

Copy the sentence in your best cursive handwriting. Then, trace and copy the common nouns.

Blank handwriting lines for copying the sentence and common nouns.

bridge school ocean

bicycle library flower

Name: \_\_\_\_\_

Parts of Speech

*A proper noun names a specific person, place, or thing.*

Copy the sentence in your best cursive handwriting. Then, trace and copy the proper nouns.

*Betsy Marnie*

*Friday*

*Haiti Taiwan*

*June*

A singular noun names one person, place, or thing.  
 A plural noun names more than one person, place, or thing.

Copy each word in the correct category. Use your best cursive handwriting.

closet

spoons

friend

basket

plants

gloves

plate

candles

Singular Nouns

Plural Nouns

Name: \_\_\_\_\_

*Verbs are words that show action.*

Copy the sentence in your best cursive handwriting. Then, trace and copy the verbs.

-----

-----

-----

-----

-----

-----

-----

-----

-----

-----

-----

-----

-----

-----

-----

-----

-----

-----

-----

-----

-----

*eat skate paint*

*fix read clean*

copy each word in the correct category. Use your best cursive handwriting.

*listen*

*Roger*

*speak*

*Leah*

*frog*

*think*

*Brazil*

*basketball*

*write*

*marker*

*blink*

*erase*

Nouns

Verbs

Name: \_\_\_\_\_

*A prefix is added to the beginning of a word to form a new word.*

Trace and copy each word in your best cursive handwriting.

*misspell*

*discover*

*incomplete*

*semicircle*

*replace*

*unreal*



me:

Write the prefixes with the root words to create new words. Use your best cursive handwriting.

<i>prefixes</i>	<i>root words</i>
<i>un</i>	<i>plug finished</i>
<i>dis</i>	<i>agree function</i>
<i>re</i>	<i>act write</i>
<i>in</i>	<i>valuable correct</i>

Blank handwriting practice lines for the first column of the table.

Blank handwriting practice lines for the second column of the table.

Name: \_\_\_\_\_

A suffix is added to the end of a word to form a new word.

Trace and copy each word in your best cursive handwriting.

thoughtful

powerless

lately

childish

greatness

terrible

Write the suffixes with the root words to create new words. Use your best cursive handwriting.

root words	suffixes
quiet	by
cheer	ful
bright	ness
hope	less

Handwriting practice lines consisting of solid top and bottom lines with a dashed middle line, provided for writing the new words.

Name:

*Kyle misunderstood the question.*

*Sally spoke softly.*

*Marty was very helpful.*

*Elle rebuilt the watch.*

Copy the sentences in your best cursive handwriting. Circle each prefix and suffix.

A metaphor compares objects.

Trace and copy the sentences in your best cursive handwriting.

Time is money.

Bill is a teddy bear.

Sarah has a heart of gold.

Paul is a shining star.

Name: \_\_\_\_\_

A simile uses "like" or "as" to compare objects.

Trace and copy the sentences in your best cursive handwriting.

*Pete is as busy as a bee.*

*Nancy is sly like a fox.*

*Bob is as curious as a cat.*

*Lois can sing like a bird.*

*A fact is a true piece of information.  
An opinion is a belief that someone  
has about something.*

Copy the sentences in your best cursive handwriting.

Handwriting practice lines consisting of multiple sets of three horizontal lines: a solid top line, a dashed middle line, and a solid bottom line.

Name: \_\_\_\_\_

*Facts About Plants*

*Plants need sun and water to grow.*

*Some plants have flowers.*

*Fruits and vegetables come from plants.*

Copy the sentences in your best cursive handwriting.

Handwriting practice lines consisting of a solid top line, a dashed middle line, and a solid bottom line. There are ten sets of these lines provided for copying the text above.



*Opinions About Plants*

*Everyone should plant a flower garden.*

*Vegetables make tasty snacks.*

*Daisies are the prettiest flowers.*

Copy the sentences in your best cursive handwriting.

Handwriting practice lines consisting of multiple rows of solid top and bottom lines with a dashed midline.

Name: \_\_\_\_\_

Fact and Opinion

Copy each sentence in the correct category. Use your best cursive handwriting.

*Dinosaurs are fun to draw.*

*Dinosaurs were reptiles.*

*Scientists study dinosaurs.*

*Dinosaurs were scary.*

Facts

\_\_\_\_\_

\_\_\_\_\_

\_\_\_\_\_

\_\_\_\_\_

\_\_\_\_\_

Opinions

\_\_\_\_\_

\_\_\_\_\_

\_\_\_\_\_

\_\_\_\_\_

\_\_\_\_\_

My  
Tongue Twister  
Booklet

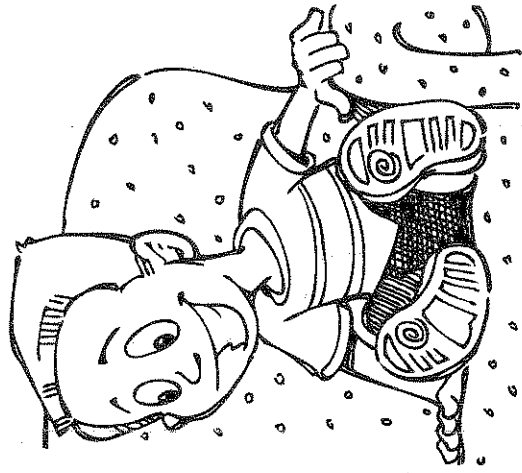

Name: \_\_\_\_\_

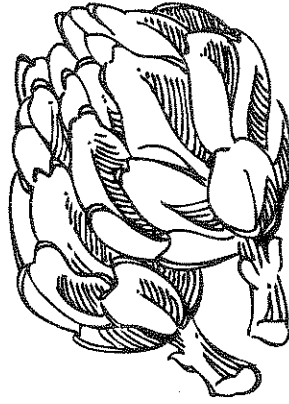

Abigail Applewhite  
ate artichokes.

Name: \_\_\_\_\_

Bertina Baker blew  
up blue balloons.

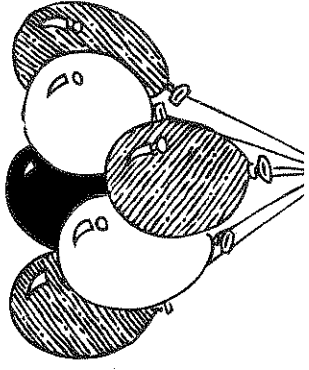

Name: \_\_\_\_\_

Clifford clumsily  
closed the closet.

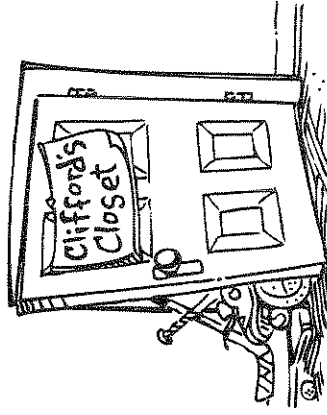

me:

Lawrence Swindle  
drew a dinosaur.

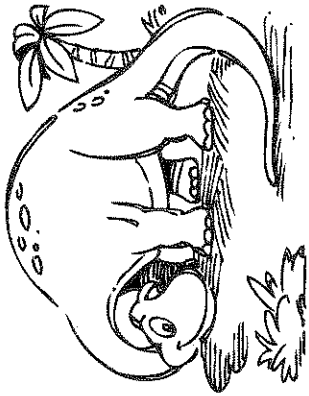

Name:

Ermer Sturood eyed  
am elderly elephant.

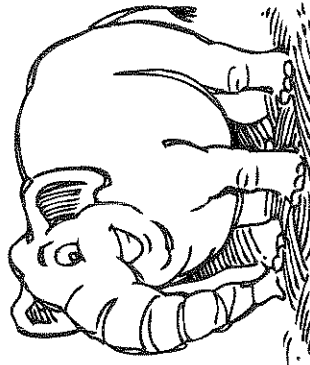

Name: \_\_\_\_\_

Floyd flingde flipped  
flat flapjacks.

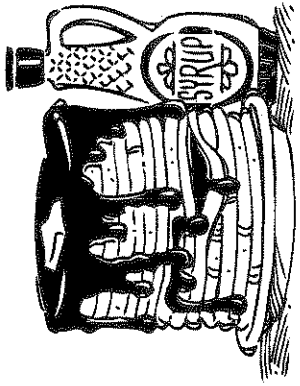

Name: \_\_\_\_\_

Greta Grabber grabbed  
green grapes.

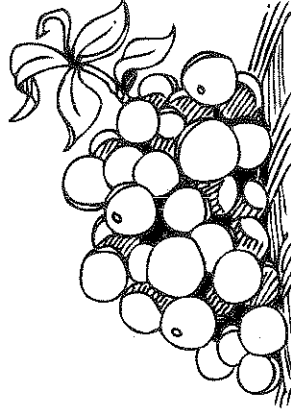

me:

Hedya Hemadria hugged  
a happy hippo.

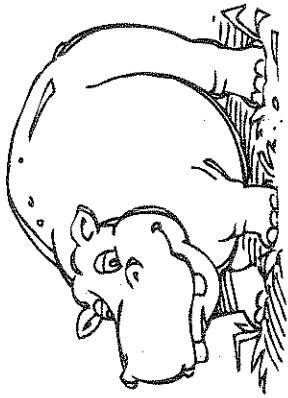

Name:

Sara Sory identified  
ivory irises.



Name: \_\_\_\_\_

Judie Jackson juggled  
jetty beams.

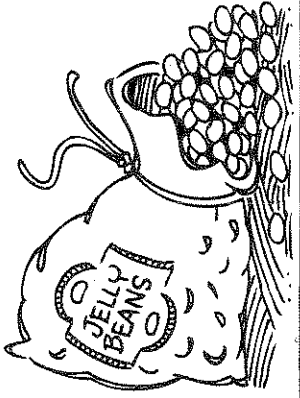

Name: \_\_\_\_\_

Harb Kemmer kindly  
keeps ketchup.

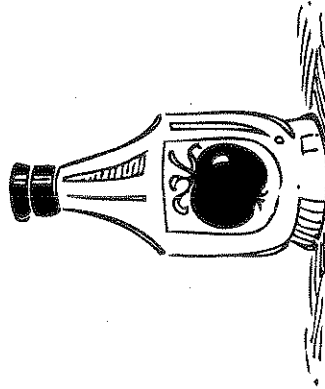



me:

Lila Leabetter dugged  
lots of bitter lemons.

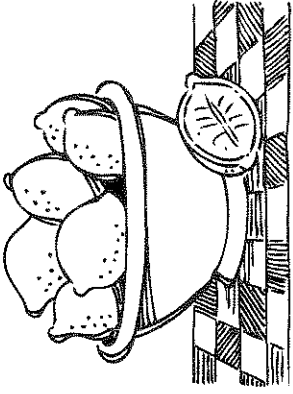

Name:

Milton Mallard  
mailed mangoes.

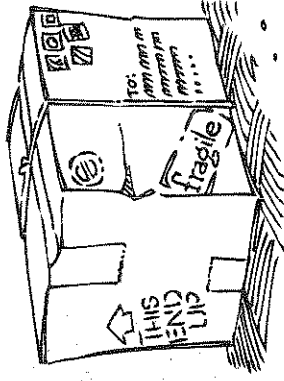

Name: \_\_\_\_\_

*Floris Newton never  
needs new noodles.*

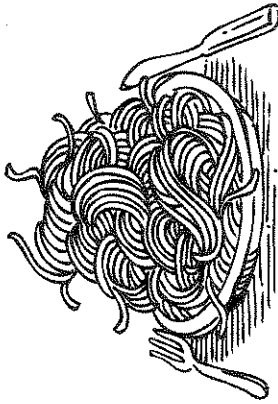

Name: \_\_\_\_\_

*Ellie Oliver ordered  
olives in oil.*



me:

Patty Plaster picked  
purple pansies.



Name:

Quincy Quill quieted  
the quartet.

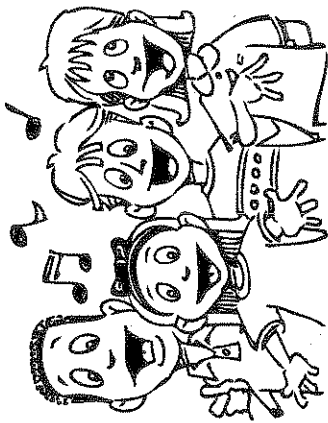

Name: \_\_\_\_\_

Randy Roberts ran  
with a rare rabbit.

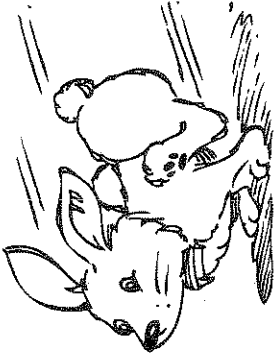

Name: \_\_\_\_\_

Sally Singer smiles  
in her shiny shirt.



Name: \_\_\_\_\_

Timmy Toppo tiptoed  
toward a tree house

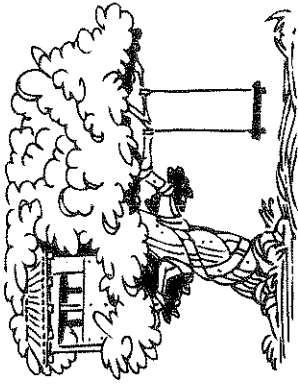

Name: \_\_\_\_\_

Uri Uddall used his  
unusual unicycle.

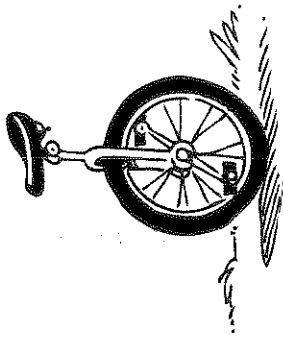

Name: \_\_\_\_\_

*Dicky Dim viewed a*

*merry wabwable wase.*

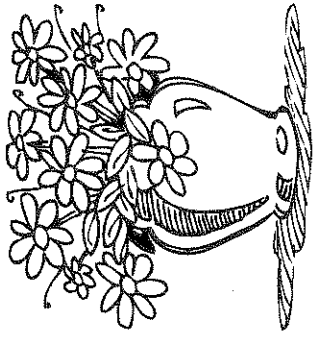

Name: \_\_\_\_\_

*Walt Waters watched*

*the weary wabrus.*



me:

karrier kao expected  
extra k-rays.

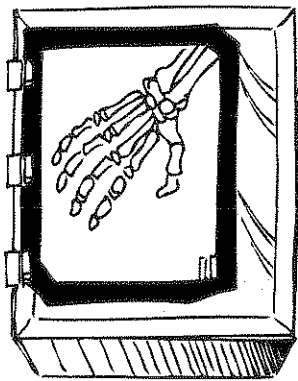

Name:

golanda yeats yodeled  
yonder yesterday.



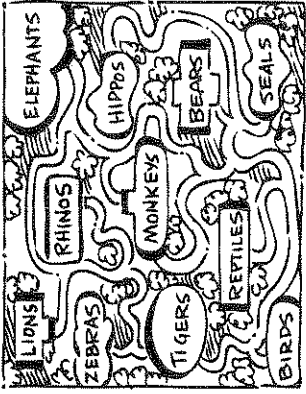

Name: \_\_\_\_\_

Jenny Jane giggled  
through the zoo.

